

2 Reports

Reports

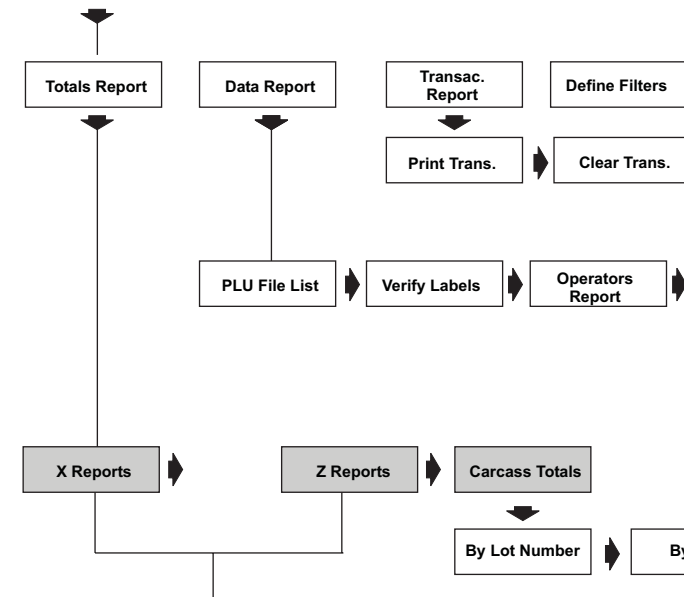

3 System Setup

System Setup

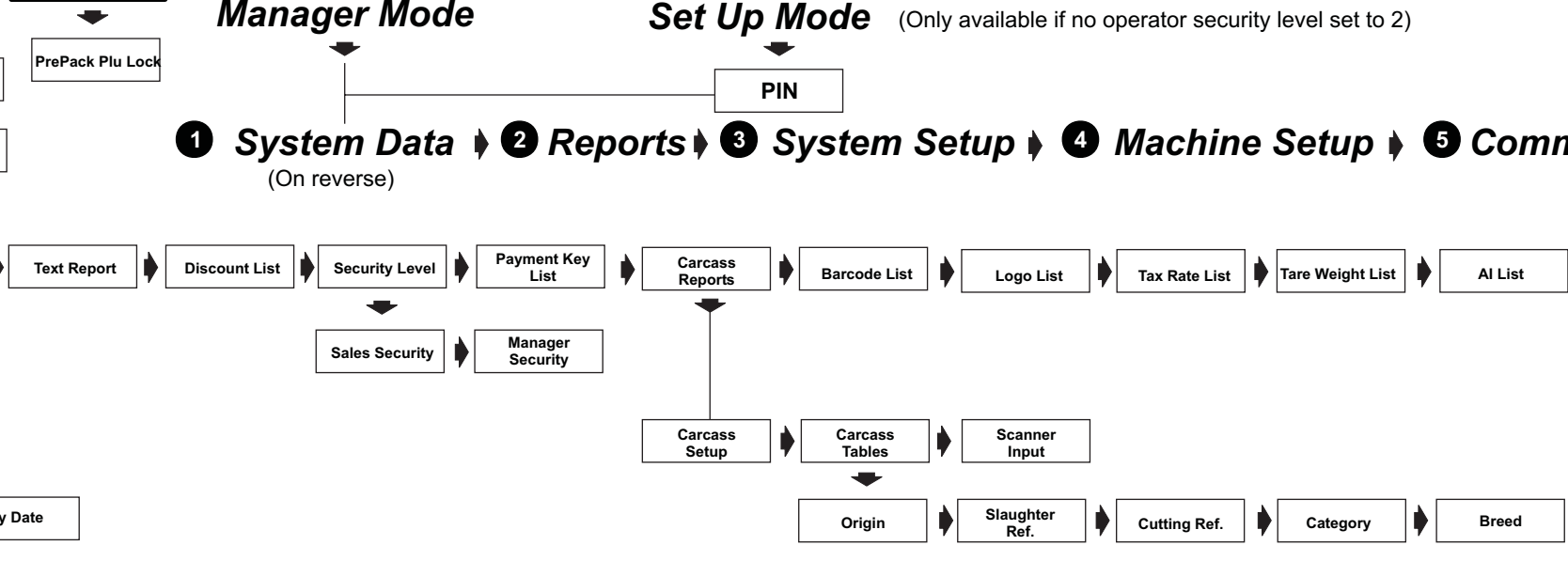

Manager Mode

Set Up Mode

(Only available if no operator security level set to 2)

1 System Data → 2 Reports → 3 System Setup → 4 Machine Setup → 5 Communications → 6 Data Backup  
(On reverse)

ENTER   ←   →

↓   ↑   ↓

Security can be applied to this menu

4 Machine Setup

Machine Setup

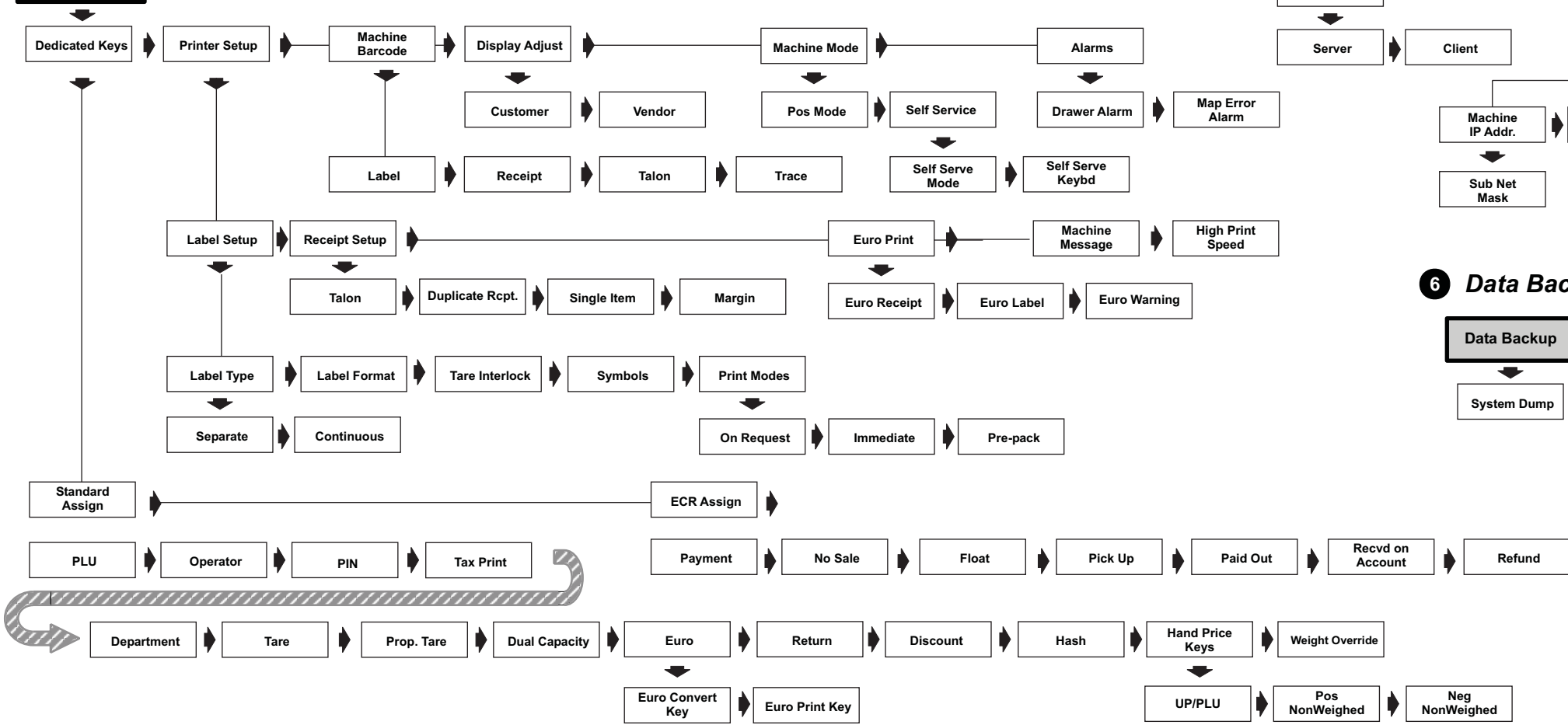

5 Communications

Communication

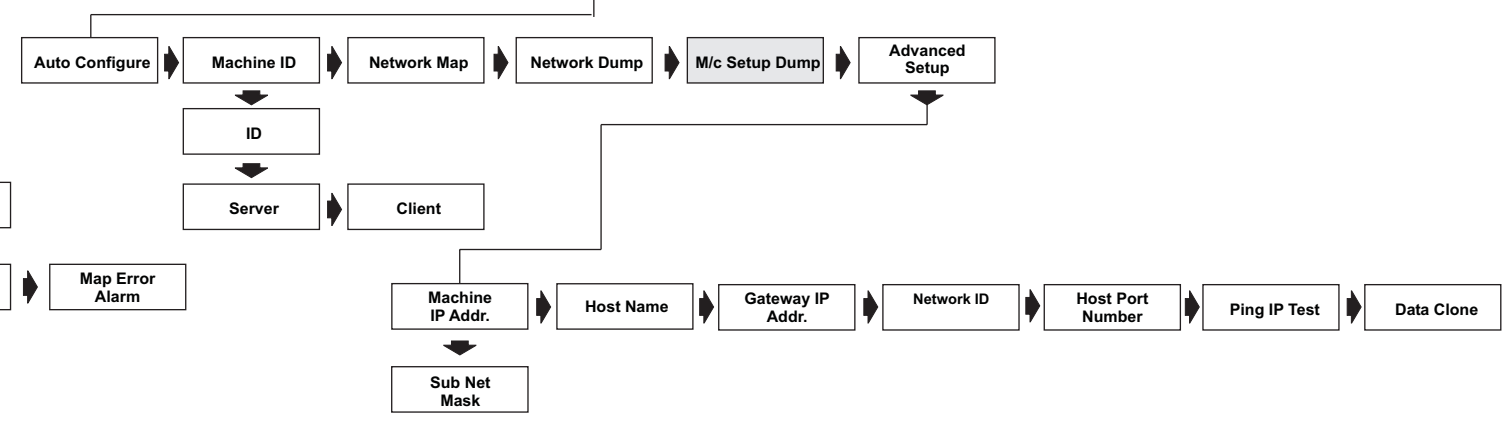

6 Data Backup

Data Backup

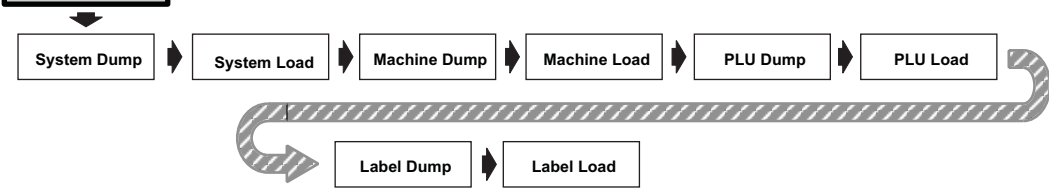

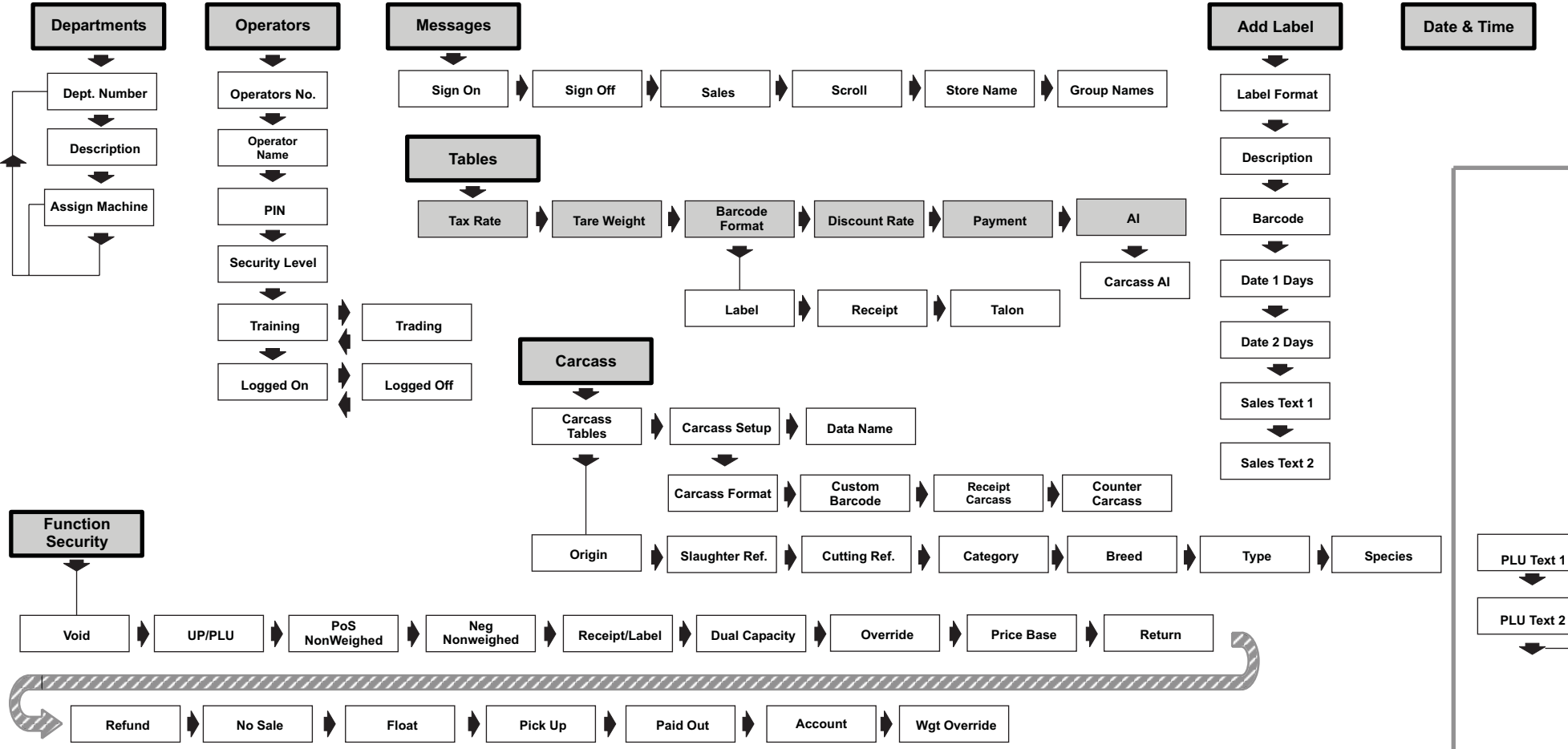
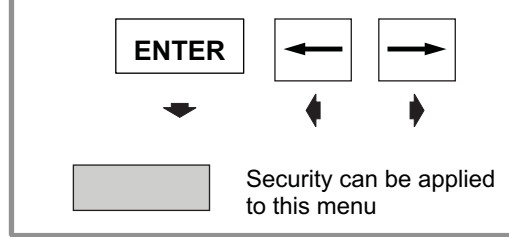

Product Programming

Create & Edit

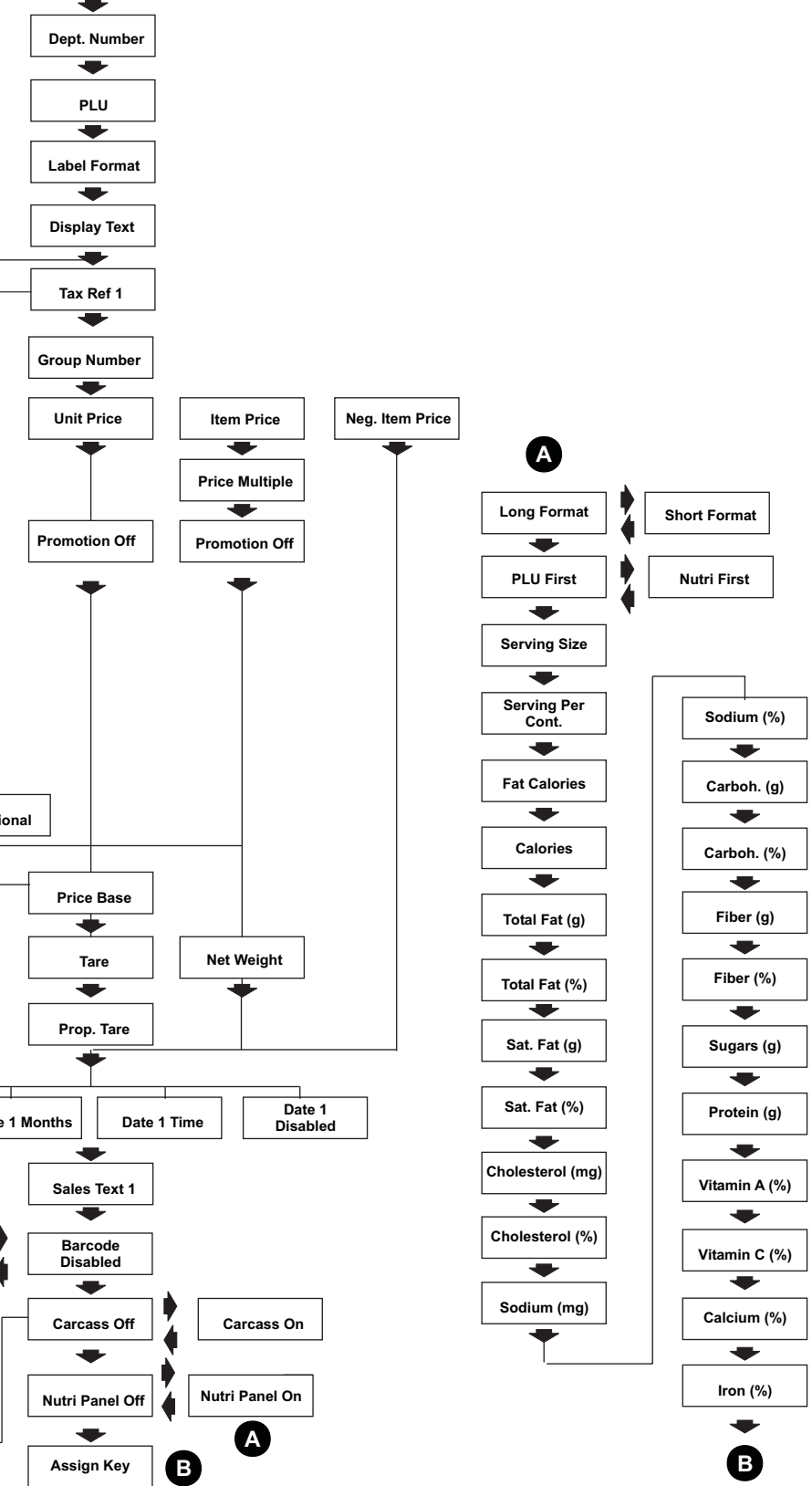

Change Price

Delete PLU

Copy PLU

Customize Menu

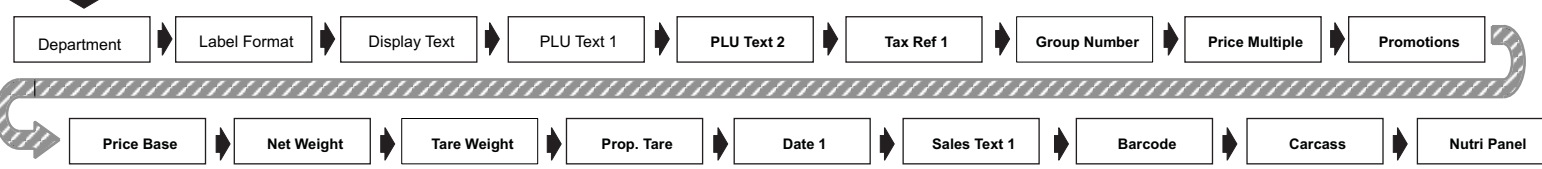
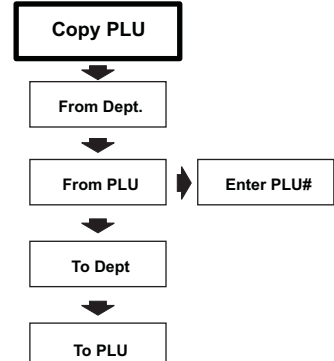
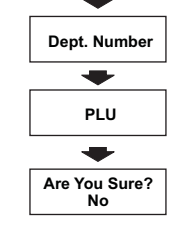
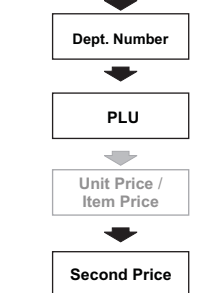
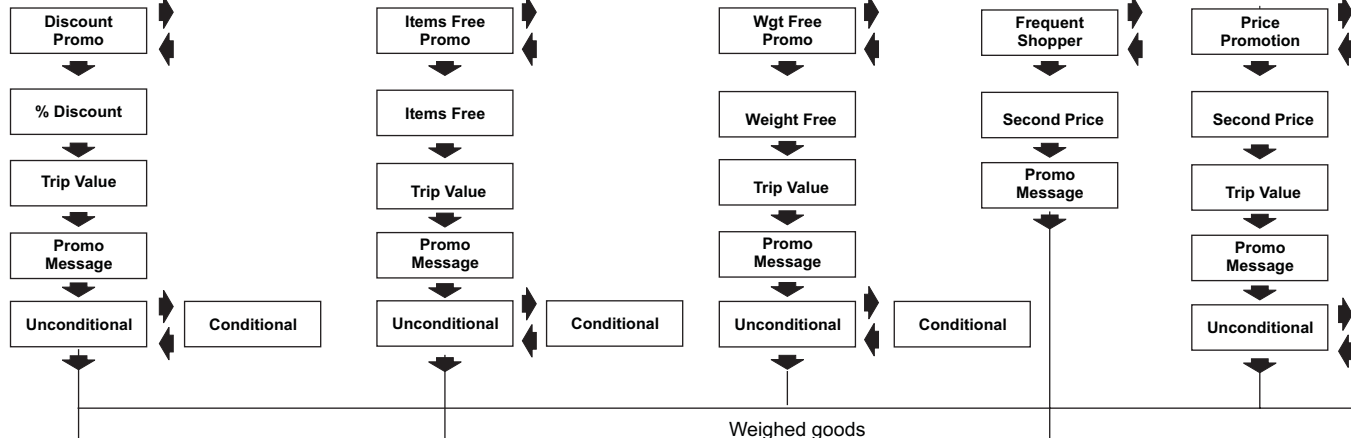

B

A

B

A