

CAN OPENER

INSTRUCTIONS

Please read carefully
&
keep this card

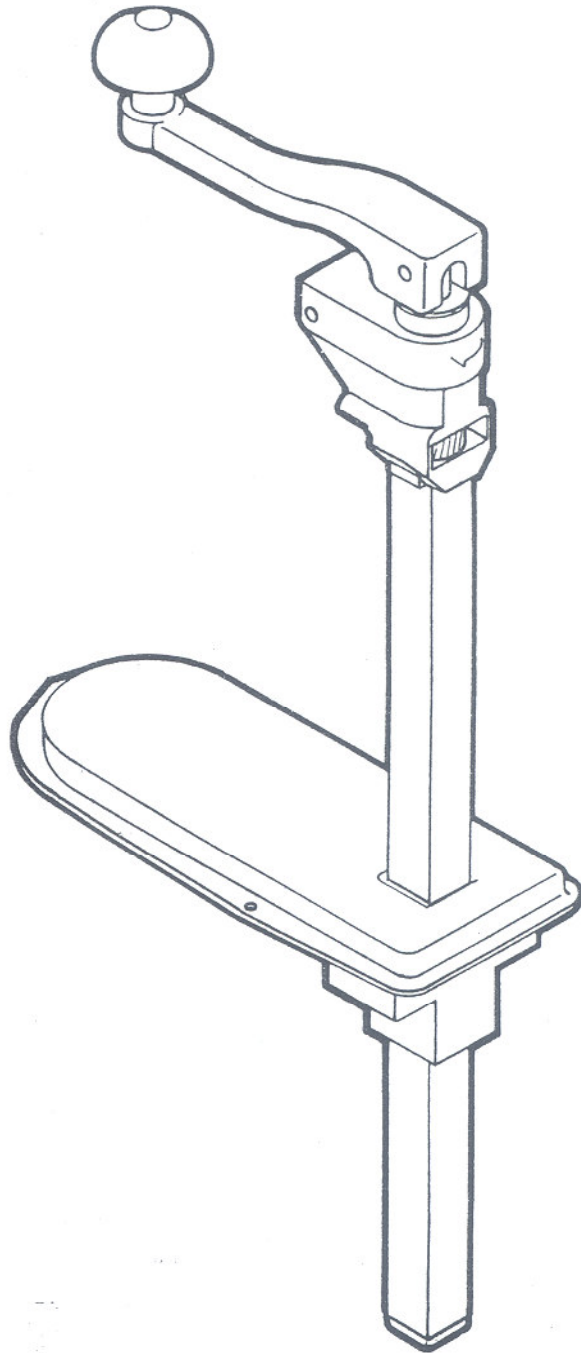

OPERATION

- A. To obtain best results from your Can Opener please follow our operating, cleaning and maintenance instructions.
- NB: Badly damaged can rims should be straightened with pliers before opening.
- B. Affix platform securely to a firm work surface, using the screws provided

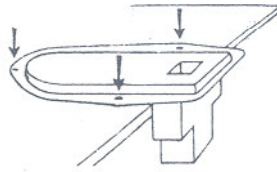

- C. Slide can opener tube through aperture in platform.

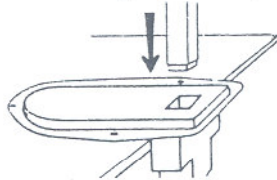

- D. Position can on platform and, with handle in vertical position, punch blade through lid.

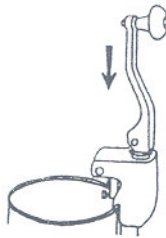

- E. Lower handle through 90° into turning position.

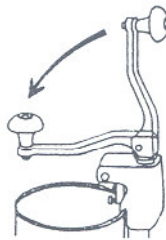

- F. Open can by turning handle clockwise. Raise handle through 90° to release and remove can.

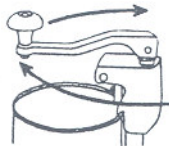

CLEANING

- A. Can openers should be cleaned on a regular basis, depending on the amount of use.
- B. Clean with hot water and brush, Rinse with clean water, detergents or soap etc. can affect durability of painted and plated surfaces.
- C. Dry can opener thoroughly. Moving parts do not require lubrication, but blade and wheel contact surfaces may be protected against corrosion with vegetable oil or Vaseline.

MAINTENANCE

Blade — check for wear regularly, test cutting edge with fingernail for evidence of groove or nick.

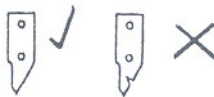

Wheel — check gear teeth for wear — opener will tend to slip if gear is worn.

Platform — check that fixing is secure.

Check that can opener leans to left when viewed from operating position, if opener is vertical during operation, platform is worn and opener will tend to slip, or will not open complete can in one operation.